



Your FTTP user guide

Useful information about your
nbn[®] supplied equipment

Before performing any maintenance
please read the important safety
warnings on the back cover.

Your nbn user guide

Getting started	4
Plugging your devices into your nbn connection box*	5
Identifying your nbn supplied equipment	6
Maintaining your nbn supplied equipment	8
Frequently asked questions	10
nbn connection box indicator lights	14
Optional Power Supply with Battery Backup guide	16
Managing the Power Supply with Battery Backup	17
Emergency calls checklist	19
Connecting to the mains power supply	20
How to replace your backup battery	22
What to do if the mains power fails	24
Power Supply with Battery Backup indicator lights and alarm sounds	25
Troubleshooting	26
Phone and Internet troubleshooting	27
Important safety warnings	28

*Also known as Network Termination Device (NTD).

Congratulations on connecting to the **nbn** network. With your new Fibre to the Premises (FTTP) connection, you'll be able to access the benefits of fast and reliable phone and internet services, including:



Faster speed options

A fast **nbn** FTTP connection will give you access to plans based on lightning-fast wholesale speed tiers for faster downloads of large files and more.#



A more reliable connection

With a more reliable connection, you'll be able to access better support for super high-quality streaming, even when more people are online at once.#



Designed for the future

Connecting to FTTP technology will help to future-proof your home, ensuring it's better able to handle higher levels of demand or advancements in technology.#

This booklet gives you the information you need to ensure your **nbn** supplied equipment stays in good working order. It also outlines the things you can do if your system is not working properly.

#Your experience, including the speeds actually achieved over the nbn network, depends on the nbn network technology and configuration over which services are delivered to your premises, whether you are using the internet during the busy period, and some factors outside of nbn's control (like your equipment quality, software, chosen broadband plan, signal reception, or how your provider designs its network)

Getting started

Once your **nbn** connection box has been installed and your phone and internet provider has advised your services are now active, just follow the simple steps below to begin enjoying your new service over the **nbn** network.

- 1 Connect any compatible equipment to the **nbn** connection box. Use the port designated for that service **C** as directed by your phone and internet provider. Further information on the ports can be found on the next page. **To remove the cover to access the ports, refer to the diagram below.**
- 2 If you have arranged a phone service to be supplied through the voice (UNI-V) port then your phone should be connected to the designated active voice (UNI-V) port on the **nbn** connection box **D** (or to your existing phone sockets if a registered cabler has wired them up to your **nbn** connection box). Your phone and internet provider will also let you know which connection to use.

Removing the **nbn** connection box cover

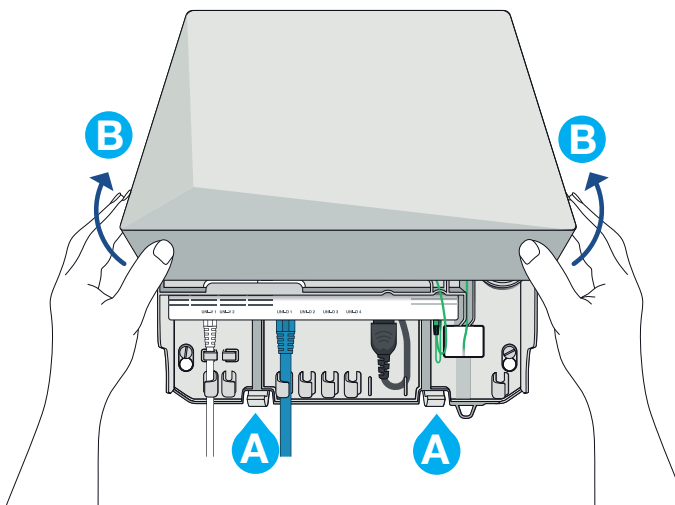

Press the two clips **A** to release the cover.
Lift the cover at an angle to remove **B**.

nbn connection box (with cover removed)

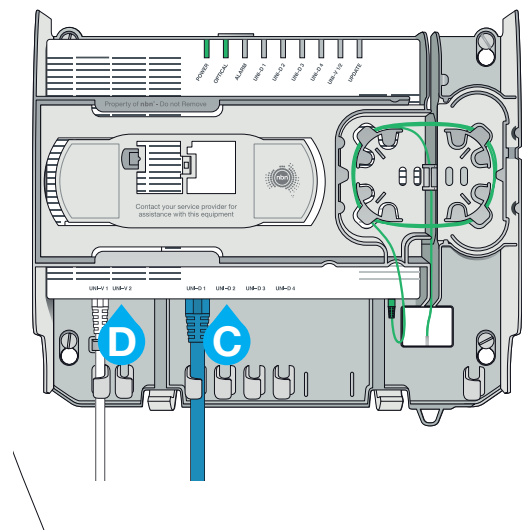

Things to note

- ✓ If you have the Power Supply with Battery Backup, the 'system status' light on it should glow green.
- ✓ The **nbn** connection box 'power' and 'optical' lights will both glow green.

For more information on indicator lights, see pages 14-15 and 25.

Plugging your devices into your nbn connection box

The bottom of your **nbn** connection box (inside the cover that is mounted to the wall) will have a row of ports that look like this:

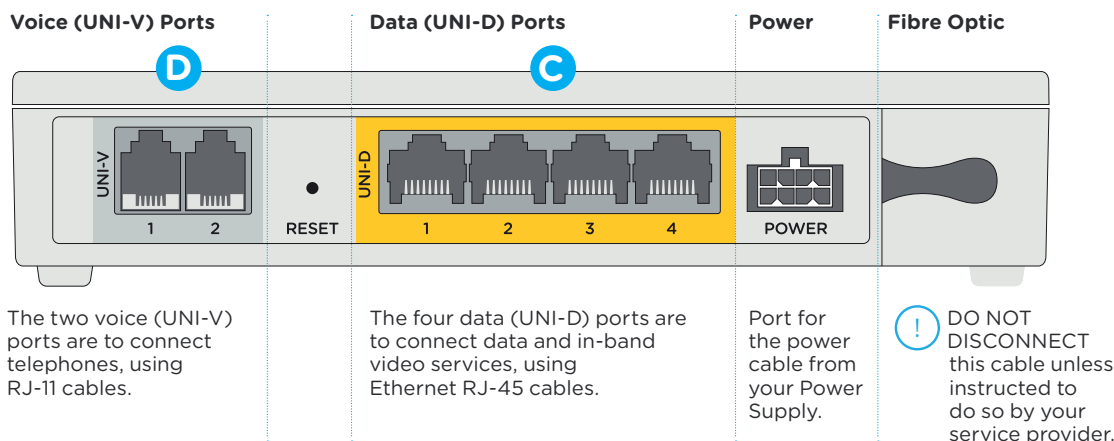

Connecting your phone service

If you have chosen a phone service from your provider to be delivered through a voice (UNI-V) or data (UNI-D) port, your provider will advise you how to connect your phone(s).

Connecting your broadband service

Your broadband services will be delivered through the data (UNI-D) ports on the **nbn** connection box. Your provider(s) will advise you which data (UNI-D) ports they have designated for your services, and how to connect any necessary equipment to these services.

Additional cables

All the power and fibre optic cables required for the **nbn** connection box to operate will be supplied and connected free of charge by your **nbn** approved installer. If other cables are needed to connect your computer, router, phone or other devices, to the **nbn** connection box, you or your provider will need to provide them.

Troubleshooting

If you've followed the instructions from your provider but your phone, internet or other broadband connections are still not working, or if you see any red flashing lights on the **nbn** connection box or optional Power Supply with Battery Backup unit, please read the troubleshooting guide on page 26.



Important notice! Risk of eye injury.

Please do NOT disconnect, tamper with or look into the laser light beam from the fibre optic cable as this could damage your eyes.

Identifying your nbn supplied equipment

nbn supplied equipment may be installed several different ways depending on your building type and requirements. These diagrams show the three main combinations of equipment and will help you identify what each piece of equipment is for. In regards to the optional battery back up, you will need to speak to your preferred phone and internet provider about details including availability.

With nbn connection box cover and standard power supply

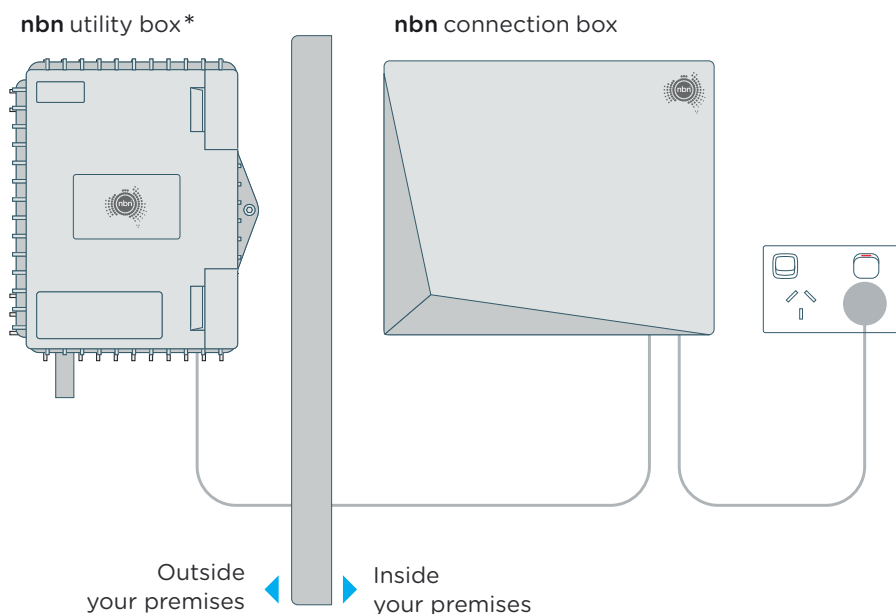

With nbn connection box cover and optional Power Supply with Battery Backup

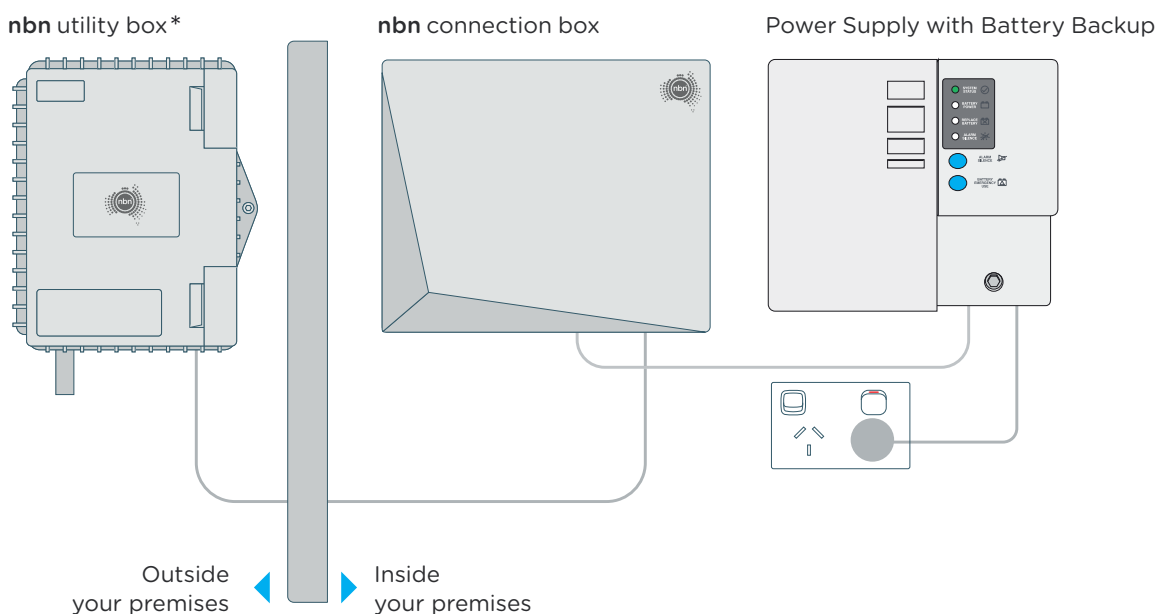

With nbn connection box (no cover), Fibre Wall Outlet and Power Supply with optional Battery Backup

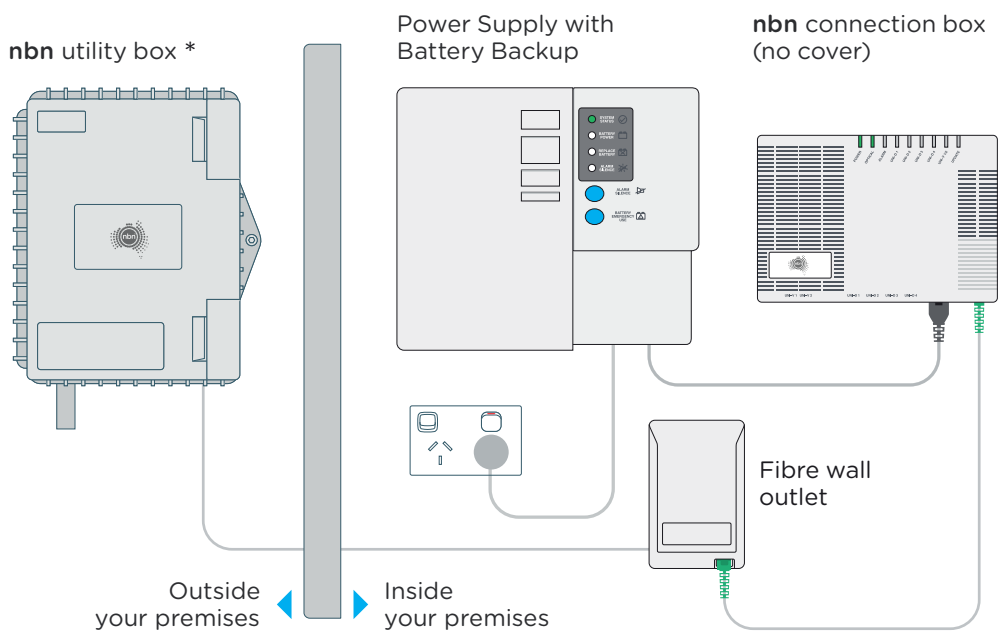

*Also known as a Premises Connection Device.

Maintaining your nbn supplied equipment

The **nbn** supplied equipment in your premises should require very little maintenance if properly cared for. Here are some important DOs and DON'Ts to ensure the **nbn** connection box and Power Supply stay in good working order.

Inside your property

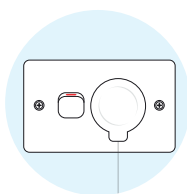

If you have the Power Supply with Battery Backup, keep it plugged in at all times with the power point switched on, otherwise your battery may wear out prematurely and your broadband data or phone services running over your **nbn** connection may not work during a power outage.

Please see section 'Optional Power Supply with Battery Backup guide' (page 16) for important information on how the Battery Backup service operates.

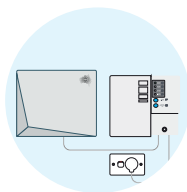

Keep the **nbn** connection box plugged into the Power Supply (whether or not you have the Battery Backup). If you don't, you won't be able to make phone calls (even in an emergency) or use broadband data services.



The indicator light will let you know when the battery needs replacing. If you have been actively using the battery during a power failure, the light may also indicate that the battery is nearly flat (see page 22 for details on how to replace the battery).

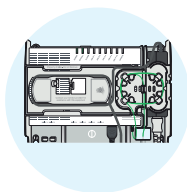

Do not touch or unloop the fibre. Tampering with the fibre (even by simply unplugging it) could damage the connection and require a technician visit.

Outside your property

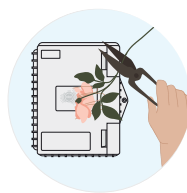

Keep branches and shrubs away from the fibre optic cable and **nbn** utility box.



Do not use water to clean the equipment.



Do not cover or paint any part of the **nbn** connection box, or Power Supply (with or without Battery Backup).

The only item that can be safely painted is the removable front cover that goes over the **nbn** connection box. This has been specifically designed to allow you to paint it. **Remove the front cover before painting it. Only use acrylic (PVA) water-based paints.**

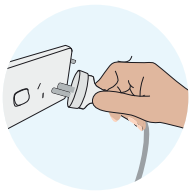

Do not unplug the **nbn** connection box or its power supply unless you need to replace the battery in a Power Supply with Battery Backup unit if you have one, or if you are going away for an extended period are otherwise directed to do so by your phone and internet provider.



Do not place objects on top of the **nbn** connection box, as this may reduce minimum ventilation requirements, causing your **nbn** connection box to operate at a higher temperature than normal.



Ensure you know where any underground cables are located before digging to avoid accidental damage to them.

It is best to always contact Dial Before You Dig by calling 1100 or via their website at www.1100.com.au. Lodging an enquiry is free of charge. You may incur costs if underground cables are accidentally damaged, and experience lengthy unplanned service disruptions until the damaged cables can be repaired.

FAQs

I've accidentally damaged the nbn connection box. What do I do?

The **nbn** connection box and its cover, Power Supply with Battery Backup, standard power supply and the fibre optic cable on your property are your responsibility to keep in good condition, just as you are responsible for your other services such as power, phone and gas.

If you happen to accidentally damage any part of the **nbn** supplied equipment or cable, please contact your phone and internet provider to have it repaired. You may be charged for the repair.

Is the nbn connection box installed in my home or premises safe?

The **nbn** connection box and its power supply only use fixed cables. That means they neither designed nor intended to emit any wireless radiation. Rest assured the **nbn** connection box and its power supply have been tested to ensure they meet: Australian Safety and Emission requirements in accordance with AS/NZS CISPR22 and AS/NZS 60950-1. These are the same standards consumer appliances are required to comply with. Both the **nbn** connection box and power supply have passed these tests.

The **nbn** connection box also has a laser warning label on it, in accordance with Australian standards. The warning on the label is the same one required for CD and laser pointing devices, laser 'spirit' level tools etc.

The **nbn** connection box is designed to automatically turn off its laser in cases when the optical fibre is pulled out or broken. The automatic switch off happens within thousandths of a second of a break occurring. **nbn** nevertheless recommends that you stay away from fallen or broken cables as a precaution because it's not always possible to tell whether a fallen or broken cable is a safe cable or an unsafe cable.

Is the nbn fibre optic cable safe?

Fibre optic cables do not conduct electricity. However, there are other safety hazards associated with handling the fibre optic cable. This is why you must never disconnect, tamper with or look directly into the laser light beamed from the fibre optic cable. Although the laser light found inside the fibre optic cabling may appear invisible, you should always assume the light is present even if you cannot see it.

Who can I contact for assistance?

If you have any questions or need help, or to report a fault, please call your provider.

Can I plug the power supply into a power board?

Yes, however **nbn** prefers the **nbn** connection box and power supply is connected to a fixed power point where possible. However in the event this is not possible then the power supply can be plugged into a double adapter, extension cord or power board as long as they are safe.

If I'm going away for a while – can I unplug my service to save power?

nbn recommends leaving your **nbn** supplied equipment connected and powered at all times. You may shorten the life of your battery if you leave the Power Supply with Battery Backup unplugged for an extended period of time. However, if you are away for an extended period, and do not want to leave the **nbn** supplied equipment plugged in, please be sure to disconnect the battery by following these steps (refer to diagram on pages 22–23):

1. Turn off at the power point and disconnect the power supply from the mains power.
2. Open the front cover of the Power Supply with Battery Backup **A**
3. Disconnect the red '+' plug from the battery **B**

When returning, please remember to reconnect the battery. If you don't, your phone and broadband data services won't work during a power failure, you may hear audible alarms and your provider may be alerted that your battery needs servicing.

What if I want to move the **nbn** connection box?

If you need to have the **nbn** connection box or the cables relocated, contact your provider to arrange for a technician to move the equipment. Please note, relocation charges will apply. Your provider will be able to advise on the cost. When considering relocating **nbn** supplied equipment or cables, there are some technical and occupational health and safety (OH&S) issues to keep in mind, including:

- The equipment must be protected from water, steam or excessive heat.
- The location must be well ventilated, near a fixed power point and easy for you to check the indicator lights.
- The equipment must be positioned in a location away from busy areas and protected from risk of damage. There should also be sufficient light for you to see if the device is functioning correctly.

Can I connect other devices to the unused ports on the **nbn** connection box?

Unlike modem/routers you might be familiar with from ADSL and cable broadband services, each port on the **nbn** connection box is reserved for a separate service. This allows you to have up to four separate broadband data and up to two separate phone services through one connection box. If you only order one broadband service, then only one port will be active. If you connect one of your devices to an unused **nbn** connection box port, your devices won't be connected to a phone or internet service.

I have a monitored home or premises security system. Will it work over the nbn network?

It is expected that most monitored security systems will operate over the **nbn** network. However, if you would like to use an existing system, you should check with your security provider to ensure that your particular equipment and service is **nbn** network compatible. You should test your alarm the same day that your service over the **nbn** network is activated by your phone and internet provider, and also check that your in-premises wiring is correctly connected up to your service over the **nbn** network. For further information on alarms and the **nbn** network, visit nbn.com.au/alarms

Can I install in-home cabling myself?

nbn will professionally install the cabling from the street to your **nbn** connection box (for more information on what's included in a standard installation please visit nbn.com.au/fibreinstallation). If you choose to install additional permanent phone or data cabling through wall, floor or ceiling cavities it must be done by a cabler registered with an Australian Communications and Media Authority (ACMA) accredited industry registrar.

Your phone and internet provider may also be able to recommend a registered cabler in your area. Other non-permanent cabling, such as plugging your own router or phone into the **nbn** connection box, can be done yourself.

How do I care for the nbn connection box cover?

You can clean the **nbn** connection box cover by removing the cover and wiping it clean with a damp cloth and mild all-purpose cleaner. Do not use a damp cloth on internal equipment or cables.

Can I lock the nbn connection box cover?

A locking feature is available to restrict access if desired. **nbn** recommends a cable tie or small padlock to stop unwanted access. Please note: Your provider should not lock the cover, as you may need to access the ports or lights inside the cover for troubleshooting or if you decide to change providers/devices.

How do I open my nbn connection box cover?

To remove the cover, press the two clips at the base of the box (either together or one at a time). Pull the base of the cover out, and then up to remove it completely. To reattach the cover, simply place the top over the base then lightly guide the cover down and back until it clips into place. Do not touch or uncoil the cables that have been installed inside the cover as this could affect the performance of your service.

Can I remove my Power Supply with Battery Backup if I no longer want the Battery Backup service and only want the standard power supply?

No, this is currently not possible. However you can advise your phone and internet provider that you no longer want the Battery Backup service which means you can remove the battery (provided no other users of **nbn** approved services are using the Battery Backup service on your premises) and your service provider will stop sending you battery alarm reminders. If you do this, your services will only operate if the power is switched on at the power point; they won't work during a power failure.

I only have the standard power supply. Can I add a Power Supply with Battery Backup if my circumstances change or I move into a home that does not have the capability and I require this service?

Yes this is possible. Please contact your phone and internet provider to discuss your needs and arrange an appointment for the installation of the Power Supply with Battery Backup. Please note that until your Power Supply with Battery Backup is installed, your services will not operate during a power failure or when the power for the **nbn** connection box is switched off at the power point.

I have moved into a house with **nbn FTTP connection installed. Do I need to do anything to make sure the Battery Backup service is working?**

If you move into a house where **nbn** fibre is available, please let your preferred phone and internet provider know whether you require the Battery Backup service when arranging your services over the **nbn** network.

If you do require it, your provider may need to arrange **nbn** to install a Power Supply with Battery Backup if there is not already one there in the house. Your provider will also remind you when the battery is worn out and needs to be changed.

You can check if the Power Supply with Battery Backup has a working battery installed in it by checking if there are any visual light alarms on the unit and opening the power supply cover to see if a battery is installed. Please follow the instructions on page 22.



If you don't require the Battery Backup service, and there is already a Power Supply Unit with Battery Backup installed, then your provider can turn off the reminders to replace the battery.



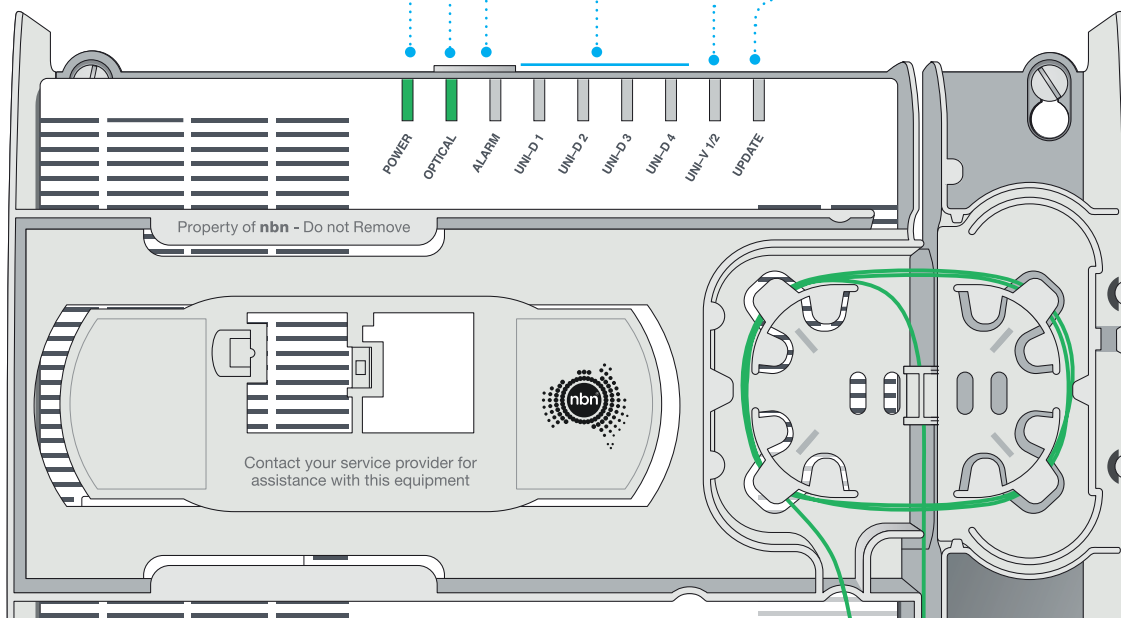

nbn connection box indicator lights



Indicator	Meaning	Action
● Off	This means there is no power to your nbn connection box	Check the power supply is plugged in and switched on and is connected to your nbn connection box. If there is still no power light, contact your phone and internet provider
● Red	Your power supply is operating on backup battery power	If there is a mains power failure, you will only have services over the nbn for a limited period of up to five hours. Refer to the Power Supply with Battery Backup section of this guide
● Green	Your power supply is working normally	No action is required
● Green Flashing	Your nbn connection box is starting up	No action is required. The flashing light should turn into a green solid light shortly



Indicator	Meaning	Action
● Off	Your nbn connection box has been disabled externally	Contact your provider for further instructions
● Red	Your nbn connection box has lost connection with the fibre network	Contact your service provider for further instructions
● Green	Your nbn connection box is connected and working properly	No action is required
● Green Flashing	Your nbn connection box is connected and working properly	No action is required



Alarm Indicator	Indicator	Meaning	Action
	 Off	Your nbn connection box is working but you have no devices connected	No action is required
	 Red	Your nbn connection box has a fault and is not working normally	Contact your provider for further instructions
	 Green	Your nbn connection box is working normally and is connected	No action is required

Data (UNI-D) Indicators	Indicator	Meaning	Action
	 Off	You do not have an active service using this port at this time	This may simply mean that connected devices are not active at the moment. If you are having difficulty with connected devices then contact your provider for further instructions
	 Orange	The device connected to your UNI-D port uses 1Gbps Ethernet	No action is required
	 Orange Flashing	The device connected to your UNI-D port uses 1Gbps Ethernet	No action is required
	 Green	The device connected to your UNI-D port uses 10 or 100Mbps Ethernet	No action is required
 Green Flashing	The device connected to your UNI-D port uses 10 or 100Mbps Ethernet	No action is required	

Voice (UNI-V) Indicators	Indicator	Meaning	Action
	 Off	You do not have an active phone service using this port at this time	No action is required
	 Green	One or more telephones are off the hook (being used)	No action is required
 Green Flashing	One or more telephones have been off the hook for more than 1 hour	Check if someone in your household is using the phone, and if not check to see if any of your handsets have been left off the hook by accident	

Update Indicator	Indicator	Meaning	Action
	 Off	Normal	No action is required
	 Red	Your nbn connection box has failed to download software	Contact your provider for further instructions
 Green	Your nbn connection box is successfully downloading software	No action is required	

Optional Power Supply with Battery Backup guide

This section (pages 16 to 27) only applies if you have the Optional Power Supply with Battery Backup.

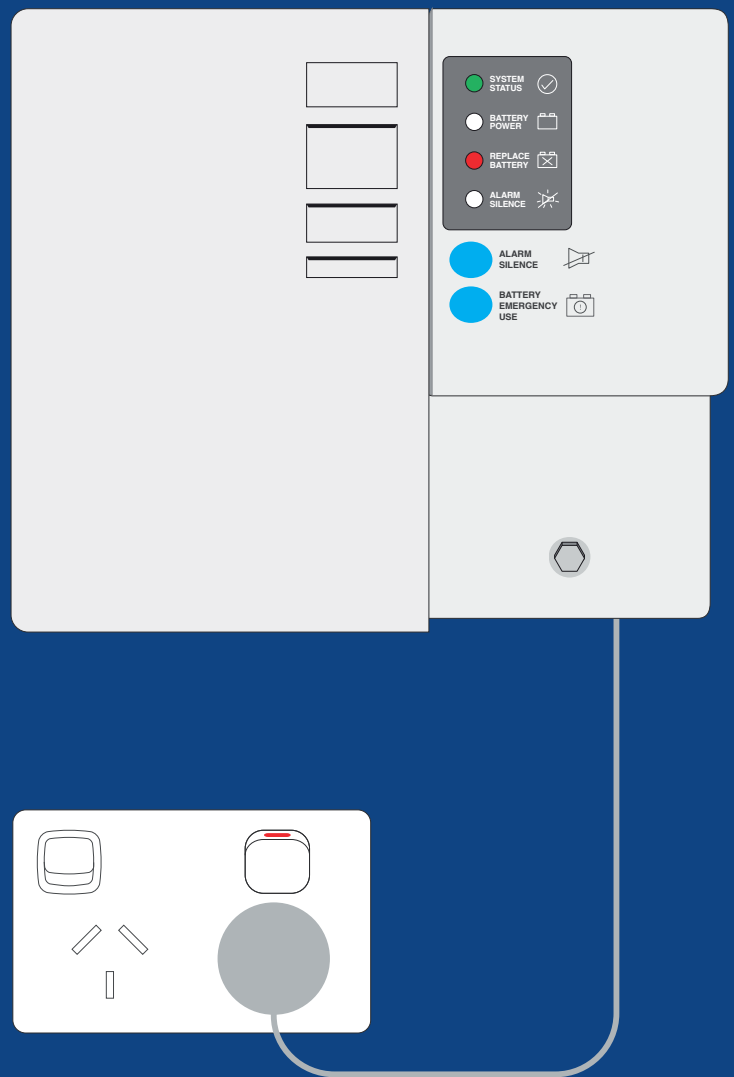

Managing the Power Supply with Battery Backup

The Power Supply with Battery Backup:



Provides a steady 12V power supply to your **nbn** connection box.



Provides battery backup power to the **nbn** connection box (when fitted with a working battery).



During a power outage, battery backup will last for approximately five hours (including the battery emergency reserve).

It is always good to have another way of calling someone during a power outage (such as a charged mobile phone) in the case of emergency.

To ensure that your phone (or data) services continue to operate during a power outage please note:

- Only standard corded phones (that don't need to be plugged into a power point) will work during a power outage, and only if your phone service is also provided over the **nbn** connection box's voice (UNI-V) port. All other devices require their own battery backup to operate during a power outage.
- If your phone plugs into a separate router/gateway from your phone and internet service provider, you won't be able to make calls unless that router/gateway also has its own battery backup.
- Examples of devices that require their own battery backup include wireless routers, all mains powered phones, computers or modem/routers.
- Uninterruptable power supply (UPS) systems help power devices during a power outage and are readily available through technology retailers.

Your provider should explain how your services can work with **nbn**'s Battery Backup and what additional solutions you may need to power your other devices.

How long Battery Backup lasts

If you have a Power Supply with Battery Backup, your **nbn** connection box will continue to be powered for approximately five hours during a power outage.

- When approximately 40% of the battery charge is remaining (after about 3 to 3.5 hours), the power supply will automatically turn off to preserve the remaining charge for emergency use.
- When you need to use the remaining charge press the emergency reserve button and within a few minutes your services will operate for the remaining approximately 1.5 to 2 hours.
- Extremely cold conditions (less than -1 degrees Celsius) may cause the battery to run out more quickly.

Keeping your backup battery topped up

To ensure the backup battery works when you need it, please maintain it by following the advice given in this guide.

- Regularly check the battery indicator lights and pay attention to audible alarms (see page 25 for a guide to indicator lights and alarms), as these may indicate a problem with your battery.
- When your battery is used as indicated in the **nbn** User Guide, it will age to about 70% of its original capacity in around three to five years.
- A battery can age sooner if not kept at room temperature (around 20 degrees). Warmer temperatures can accelerate aging of the battery.
- Turning the power on and off frequently will cause the battery to age earlier and reach 70% of its capacity in around one to two years.
- Please ensure the battery is replaced when needed (or as arranged with your phone and internet provider).

Options for extending your Battery Backup

If approximately five hours of battery backup isn't enough for your needs, you can add additional capacity by plugging the power cord of the Power Supply with Battery Backup unit into an Uninterruptible Power Supply (UPS) – itself a type of battery backup unit. These are readily available through technology retailers. Your provider should explain how your services can work with **nbn**'s Battery Backup and what additional solutions you may need to power your other devices. The UPS must supply a 230V 50Hz AC waveform in accordance with AS60038-2000. Refer to your UPS manufacturer for confirmation.

To set up a UPS, please:

- 1 Follow the instructions provided by the UPS manufacturer to initially set up the UPS system.
- 2 Switch off the power at the power point that the **nbn** connection box power supply is connected to.
- 3 Unplug the **nbn** Power Supply power cord from the power point and plug it into the UPS.
- 4 Plug the UPS power cord into the fixed power point.
- 5 Turn on the power point.
- 6 Follow the UPS manufacturer's instructions on operating the UPS.

Your provider should explain how your services can work with battery backup and what solutions you may need for your devices. You should discuss the use of any UPS with your provider.

Emergency calls checklist

To make calls during a power outage for up to five hours, you need to make sure you have all the following:

- ✓ Power Supply with Battery Backup
- ✓ **nbn's** Battery Backup service from your preferred phone and internet provider
- ✓ A phone service connected on the **nbn** connection box's UNI-V port
- ✓ A standard corded phone that doesn't need to be plugged into a power point

The corded phone needs to be plugged into the UNI-V port on the **nbn** connection box, and your Power Supply with Battery Backup needs to be working and maintained by following the instructions in this guide.

Powered for up to five hours (including emergency reserve) by Power Supply with Battery Backup

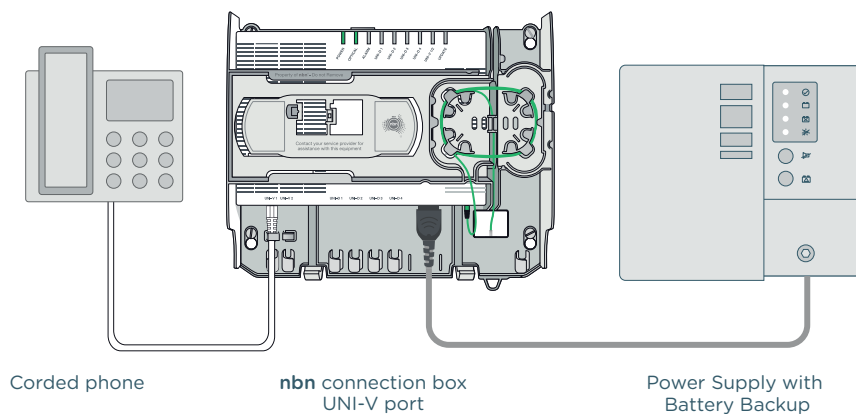

Need their own battery backup

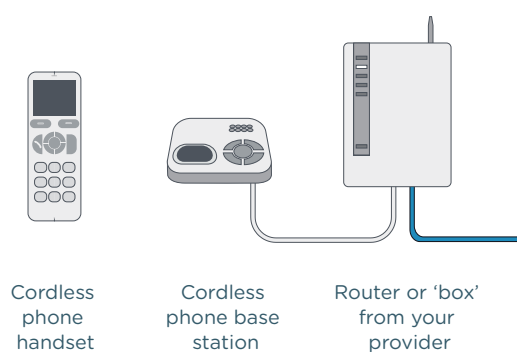

Powered for up to five hours (including emergency reserve) by **nbn** Power Supply with Battery Backup

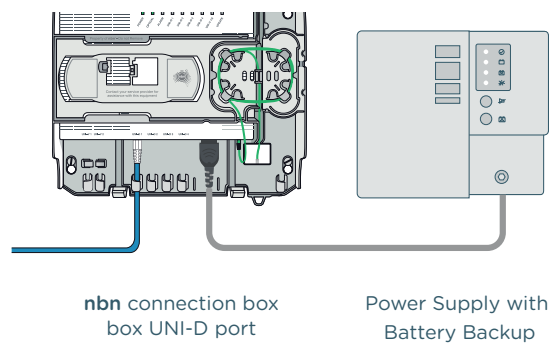

Connecting to the mains power supply

- ✓ **nbn** recommends the power supply is plugged directly into a fixed power point.
- ✓ Where a fixed power point is not available, a safe extension cord, double adapter or power board can be used.
- ✓ The **nbn** connection box will switch to battery power if you turn the power off at the power point. When the battery goes flat, the **nbn** connection box will turn off, and your phone or data services will no longer work.
- ✓ Don't switch off your **nbn** supplied equipment. The power used by the system is minimal – equivalent to a 15W light bulb.
- ✓ The life of the battery in a Power Supply with Battery Backup will be reduced if the power is routinely turned on and off, or left switched off.



What if

I connect my phone to a router provided by my phone company?

If your phone and internet provider has advised that you need to connect your phone up to a router, gateway or 'box' that is not the **nbn** connection box, then you will need to have a separate battery backup for that device. Ask your provider for advice.

I use a cordless phone?

Most cordless phone sets have batteries in the handsets, but not the base station, which usually only works when plugged into mains power. You will either need to arrange an external battery backup unit for your cordless phone base station, or buy a new cordless phone that has battery backup built into both the base station and handsets.

! Important

If your Power Supply with Battery Backup is showing a red light next to the 'REPLACE BATTERY' symbol or you hear an alarm (beeping once every 15 minutes) this either means that you need to replace your battery with a new one or that the battery has been removed. **nbn** currently provides the first battery free of charge when the Power Supply with Battery Backup is installed. It is your responsibility to discuss with your phone and internet provider whether they will supply subsequent replacement batteries or whether you should purchase them. See 'Purchase a new battery' on page 22.

If there's a power outage, your service over the nbn network won't work if the battery is faulty or missing.

If you have a Battery Backup service, your phone and internet service provider will also let you know when your battery is worn out and needs replacement or when your battery is missing. Detailed instructions on how to replace the battery are on the next page.

If you no longer want to replace the battery or need the Battery Backup service

If you no longer require a Battery Backup service and do not intend to replace the battery, let your provider know. They can stop reminding you when your battery needs replacement.

As long as no other users at the same premises have a Battery Backup service, you can remove the current battery and dispose of it at a battery recycling centre (do not place in household garbage). Refer to instructions for battery replacement for safe removal and disposal of battery on page 23. Of course, with no battery, you'll have no battery backup during a power outage, so your voice and data services will only work when plugged in and receiving mains power.

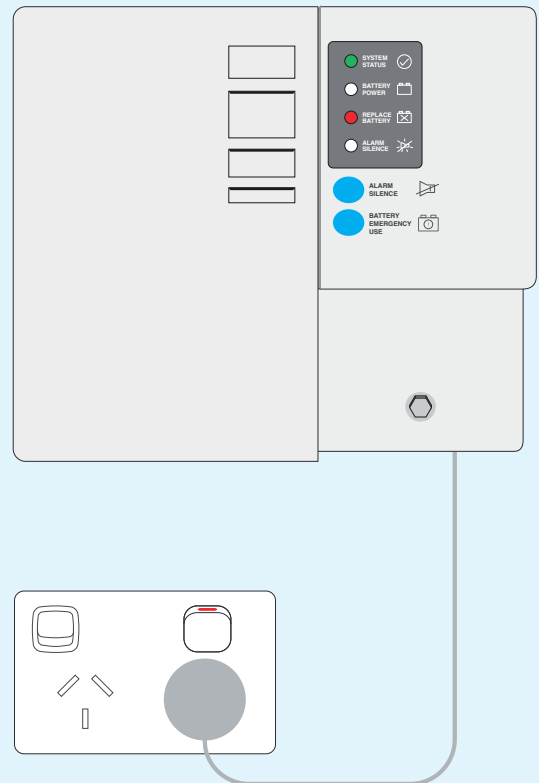

How to replace your backup battery

1

Purchase a new battery

If you and your provider have agreed you will replace the battery for your **nbn** connection box, you should buy a replacement battery that is equivalent to the original. You can purchase the battery at most specialist battery retailers – you can find a list at nbn.com.au/battery along with other useful information.

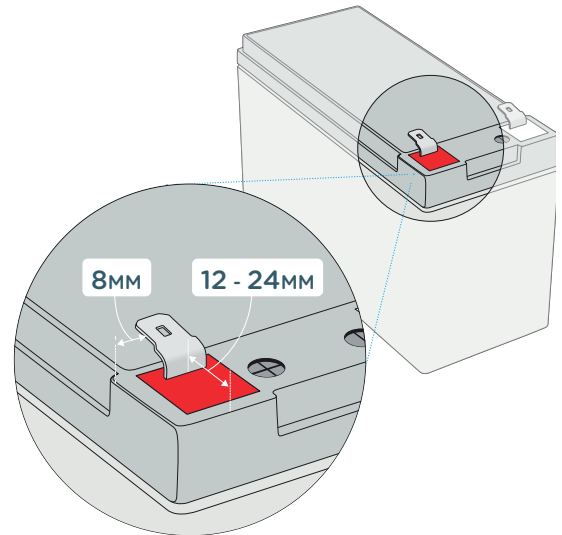

Before going any further please read the Important Safety Warnings on the back cover.

2

Remove the old battery

- Turn off at the power point and disconnect the power supply from the mains power.
- Open the front cover of the Power Supply with Battery Backup **A**.
- Disconnect the red '+' plug from the battery **B**.
- Push the tabs holding the battery, one above and one below, outward and then lift the battery out **C**.
- Disconnect the black '-' plug and remove battery **D**.

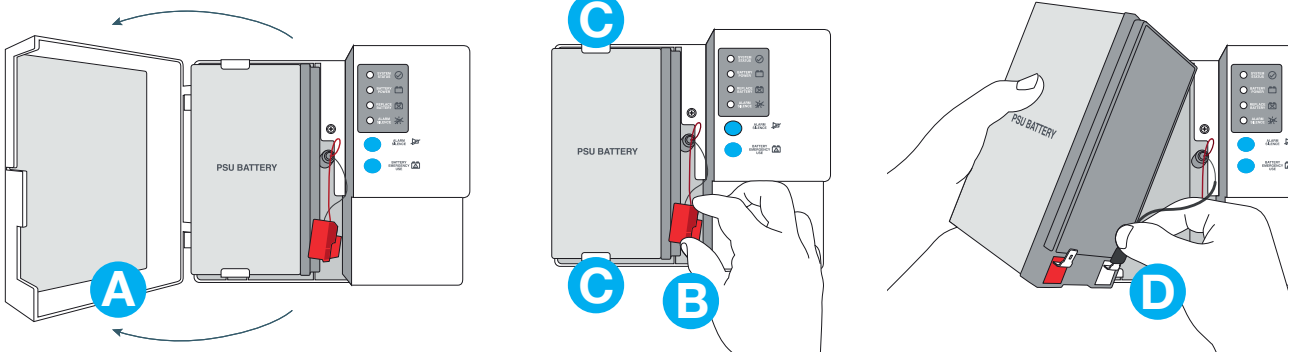

3

Install the new battery

- Reconnect the black '-' plug to the new battery.
- Push the battery retaining tabs outward and insert the battery into the Power Supply with Battery Backup **F**.
- Reconnect the red '+' plug to the new battery **G**.
- Make sure the wires are not being pinched by the battery or front cover.
- Close the front cover, plug the power supply back into the power point and turn the power on.
- The new battery will take 24 hours to completely charge. Please retain the old battery as a precaution during this time unless its charge was completely exhausted.
- Please note, your broadband and/or phone service delivered over the **nbn** network will be unavailable while the battery is being replaced and for up to 10 minutes afterwards.

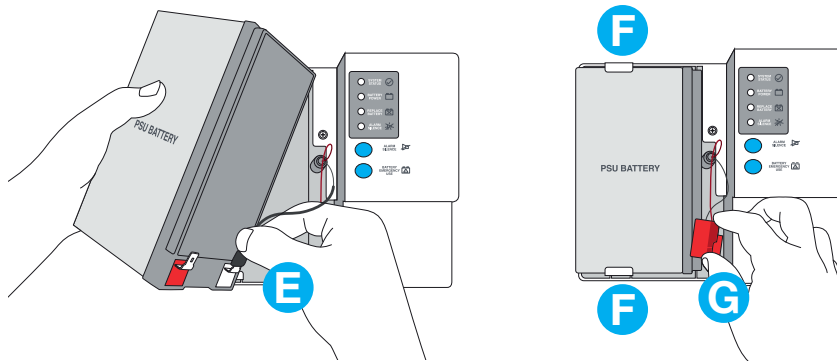

Please recycle your old battery

The Sealed Lead Batteries supplied by **nbn** are 100% recyclable. **However these batteries cannot be simply tossed in your household recycling bin as they will contaminate the rest of the recyclable material.** Please take your battery to a specialist recycling centre to be recycled.

Alternatively you could take your used battery to the store where you purchased your new battery, and ask them to recycle it for you.

Refer to **nbn's website for places to recycle lead acid batteries. You can find a list at nbn.com.au/battery**

What to do if the mains power fails

If your mains power fails, the Power Supply with Battery Backup will beep once and automatically switch to its backup battery power.

When only around 40% of the battery power remains (after about 3 to 3.5 hours), the Power Supply with Battery Backup will turn off to save the remaining 40% of backup battery power (about 1.5 to 2 hours). This saved power can then be used to make emergency calls if needed.

What happens when only 40% of the battery power remains?

The battery power indicator will flash and the Power Supply with Battery Backup will begin to beep four times a minute. Once the beeping stops, the Power Supply with Battery Backup will turn itself off to preserve the remaining power for use in case of an emergency.

How to access the remaining backup battery power in emergencies

Press and hold the BATTERY EMERGENCY USE button for two seconds until the power supply beeps once and all 4 lights flash. This will provide around a further 1.5 to 2 hours of power. After this, you can't turn the battery power off again.

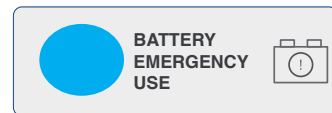

After the battery is completely flat, the BATTERY EMERGENCY USE button will not work again until mains power has been restored and the battery is recharged.

The battery is designed to be continually recharged until it has reached the end of its life and needs to be replaced - estimated to occur every three to five years if used in accordance with the guidelines.

Alarm silence function

You can silence audible alarm sounds. Press and hold the ALARM SILENCE button to temporarily silence or re-enable the alarm sounds for either 24 hours or longer:

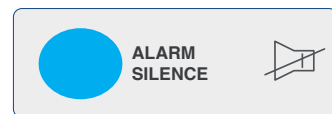











Hold button for time (seconds)	1	2	3	4	5	6	7	8	9	10	11	12	13	14	15
Silence for 24 hours 🔊														
Re-enable alarm 🔊 🔊														
Silence for 24 hours+ 🔊 keep holding alarm silence button 🔊														
Re-enable alarm 🔊 🔊 keep holding alarm silence button 🔊 🔊														

You should only silence alarms when absolutely necessary as they are designed to alert you when your battery is in need of replacement, missing or running low and will soon be flat.

= 1 beep

Power supply with Battery Backup indicator lights and alarm sounds

The following displays are present on the front of the unit:

Indicator	 Light ON	 Light BLINKING	 Light OFF
 System status 	Normal	System fault	No mains power and power supply unit is off
 Battery power 	Using battery No mains power	Battery charge low and will soon be flat	Using mains power or battery is flat
 Replace battery 	Battery missing or battery has degraded and should be replaced		Battery OK
 Alarm silence 	Audible alarms silenced	Audible alarms silenced for 24 hours	Audible alarms enabled

If the Power Supply with Battery Backup is working normally on mains power, the SYSTEM STATUS light is green and the BATTERY POWER and REPLACE BATTERY lights are off.

Alarm sounds

The following list describes the different types of audible alarm sounds you might hear

Cause	Alarm Sounds
Power Failure Loss of mains power	Beeps once
Replace Battery Battery self test fails	Beeps once every 15 minutes
Low Battery - Less than 50% remaining Battery reserve shutdown imminent	Beeps 4 times every minute
Audible Alarm On Alarm function is enabled	Beeps twice when enabled
Audible Alarm Off Alarm function is disabled	Beeps once when disabled

Troubleshooting

In the event any of the services provided through your **nbn** connection box stop working (e.g. internet, IPTV or phone) the first step is to check the following:

1

Power check

Is everything plugged in and turned on?

- **nbn** connection box
- Power Supply with Battery Backup or standard power supply
- All cables and power points
- Your own equipment

2

External fibre optic cable check

Has the fibre optic cable connection from the street been damaged?

For example, a fallen branch may have damaged the cable. If you think this may be the case, do **NOT** try to remove it or repair the cable yourself. Contact your provider immediately.

3

Indicator light check

Check the indicator lights on your Power Supply with Battery Backup and **nbn** connection box.

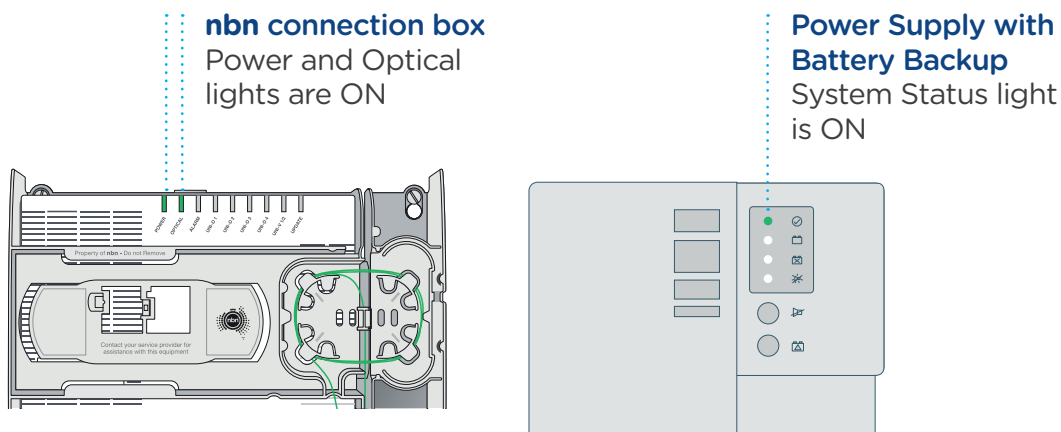

If you remove the cover from your **nbn** connection box and the lights on your **nbn** connection box or Power Supply with Battery Backup (if installed) do not match those shown in this diagram, then refer to the lights and indicators sections of this guide on pages 14-15 and 25.

Still can't identify the problem or the solution?

Please note down which lights are glowing and contact your provider for further advice.

Phone troubleshooting

If you have a phone service which plugs into the **nbn** connection box's UNI-V port, please check the following:

Things to check	Resolution
Is your phone (or if applicable, home phone wiring and wall sockets) connected to the correct voice (UNI-V) port on the nbn connection box?	If you have only ordered one phone service, then only one of the UNI-V ports on the nbn connection box will be activated.
Has the phone service ever worked?	If not, please contact your phone and internet provider to enquire whether it has been activated correctly.
Is there a dial tone?	If not, contact your provider for assistance with checking if the service is activated correctly and the phone is plugged into the right port.
If there is a dial tone but calls still don't work, are there any other tones or noises on the line that suggest the phone service isn't working normally?	These may suggest electrical interference or a fault. Contact your service provider for assistance.
If you have been plugging your phone into an existing wall socket, does it work if you unplug it and plug it into the voice (UNI-V) port of the nbn connection box?	If so, you may need to get a registered cabler to connect your wall socket wiring to the nbn connection box.
If you are using a phone extension cord, have you tried removing the phone extension cord and plugging the phone in directly to the voice (UNI-V) port of the nbn connection box?	The extension cord may be faulty.
If it still doesn't work, have you tried plugging a different phone (including a different phone cord) into the nbn connection box?	The handset may be faulty.

Internet troubleshooting

Things to check	Resolution
Has the broadband service ever worked?	If not, please contact your provider to enquire whether the service has been activated correctly.
Is your equipment plugged into the right UNI-D port on the nbn connection box?	If you have only ordered one broadband service, only one UNI-D port will be activated on the nbn connection box.
Have you tried turning the equipment you have plugged into the nbn connection box off and on?	Sometimes equipment like wireless routers may have stopped working and this can be resolved by turning the power off and on.
Have you tried using another Ethernet cable between the nbn connection box and your equipment?	It's possible the Ethernet cable is faulty and is not connecting your equipment properly to the nbn connection box.
If you are using a wireless router, have you tried testing the service over the nbn network by connecting a laptop or desktop PC to the correct UNI-D port on the nbn connection box directly via an Ethernet cable?	This will help you identify whether the nbn network service itself is not working or whether it's a problem with something else like your router.

If your phone or broadband still does not work, contact your provider for assistance.



Troubleshooting

In the event any of the services provided through your **nbn** connection box stop working (e.g. internet, IPTV or phone) the first step is to check the following:

- To reduce the risk of fire or electric shock, do not remove the cover of the Power Supply with Battery Backup except to service the battery. There are no user serviceable parts inside the Power Supply with Battery Backup except the battery.
- Please read this user guide about your **nbn** connection box thoroughly before attempting to fit or replace a battery in your Power Supply with Battery Backup.
- To avoid electric shock when servicing the battery, first switch the power point off and unplug the power cord from the wall.
- Because of the battery, there will still be live electrical components inside the Power Supply with Battery Backup, even when the power cord is disconnected from the wall or the power point is switched off. So follow the instructions on servicing the battery carefully.
- During a mains power failure, the Power Supply with Battery Backup only powers the **nbn** connection box. It will not power any other devices such as cordless phone base stations, alarms or other devices that do not have their own backup batteries.
- Never turn the power off to your power supply even if you have a Battery Backup service. Leaving the power switched off may prevent you making phone calls or using broadband services, and if you have a Battery Backup service, will shorten the lifespan of your battery.
- To prevent the risk of fire or electric shock, your Power Supply with Battery Backup should be installed in a reasonably warm, dry indoor area, free of condensation and excessive dust.

For more information:

nbn.com.au/FTTP